



THE X5 M
THE X6 M



THE BMW X5 M.
THE BMW X6 M.



18 Highlights



22 Exterior Colours



24 Interior Colours

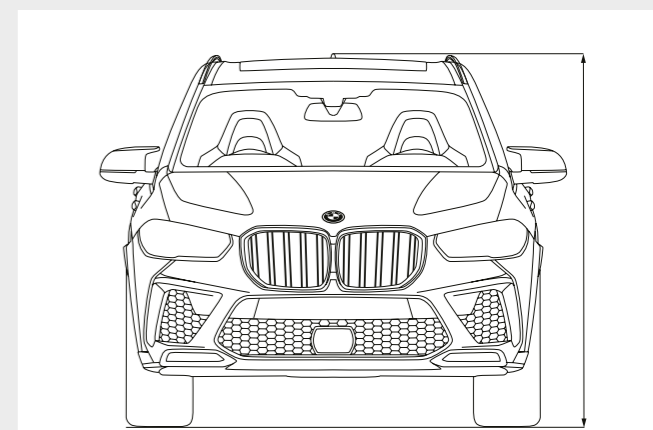

26 Technical data

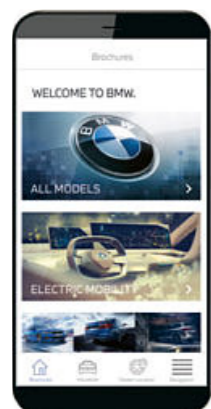

YOUR NEW SPEED DATING APP.

DOWNLOAD NOW THE BMW BROCHURES APP FROM YOUR APP STORE AND DISCOVER DRIVING PLEASURE!



DOMINANCE WITHOUT RULES.
EUPHORIA WITHOUT LIMITS.



X
6
M

ULTIMATUM TO
THE STATUS QUO.
ULTIMATUM TO



X
5
M
M



POWER: CONTROLLED.
BUT NEVER TAMED.
POWER: CONTROLLED.
BUT NEVER TAMED.

ITS TERRITORY:
THE FAST LANE.
ITS TERRITORY:
THE FAST LANE.



X
6
M



LUXURY: WITHOUT END.
DYNAMICS: WITHOUT LIMITS.



X
5
M

EXTREMELY SUPERIOR
IN ALL RESPECTS:
EXTREMELY SUPERIOR
IN ALL RESPECTS:

THE BMW X5 M
AND THE BMW X6 M.
AND THE BMW X6 M.
THE BMW X5 M.



HIGHLIGHTS.

Discover even more with the new BMW brochures app. Available now, for your smartphone and tablet.

■ Standard equipment □ Optional equipment



■ The X5 M Competition offers an increase in driving dynamics and a powerful, particularly emotional engine sound thanks to increased engine performance and M Sport exhaust system with black twin tailpipes. Distinctive exterior details in Black, the exclusive 21"/22" M light alloy wheels and the full leather trim in leather 'Merino' underline the sporty character.



□ In laser high-beam mode, BMW Laserlight in a unique X design illuminates a range of up to 500 m, nearly twice as far as that of conventional headlights. Better visibility in the dark significantly increases safety. The blue X signature and the "BMW Laser" lettering underline the vehicle's technological standards.



■ The latest version of the high-performance BMW M TwinPower Turbo 8-cylinder petrol engine guarantees performance in keeping with the latest standards. The high-revving unit develops an output of 460 kW (625 hp).¹ The two turbochargers stand out thanks to their cross-cylinder bank exhaust manifold with optimum response characteristics. The V8 engine is also designed for extreme loads on the race track.



■ The centre console is equipped with a Competition Badge¹, which emphasises the especially high performance of the X5 M Competition.



□ The M seat belts² * with belt tensioner and belt force limiter boast an exquisite stitched highlight in the classic M colours.

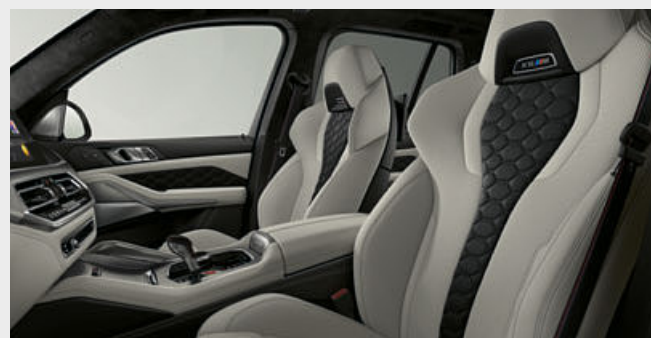

■ The M Multifunctional seats for the driver and front passenger in exclusive design and with illuminated X5 M logo on the headrest reflect the vehicle's athletic look. Lower seat bases and high side bolsters emphasize the shell-seat look and guarantee flawless lateral support. Accompanied by a comprehensive range of adjustment possibilities, maximum comfort is achieved.

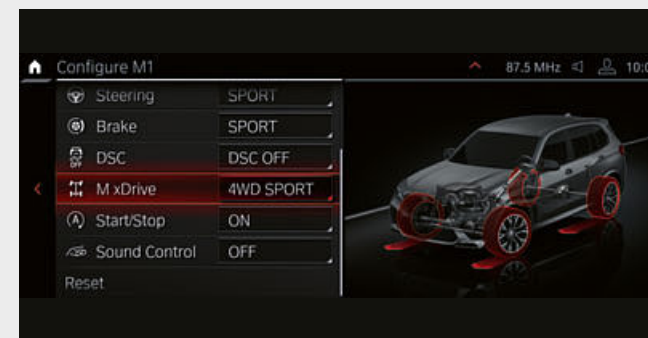

■ BMW M xDrive with Active M differential guarantees maximum traction and driving dynamics for everyday driving, as well as at the racetrack. The M specific technology combines the typical agility of a rear-wheel drive with the control of an all-wheel drive. You can choose between the two drive variants 4WD and 4WD Sport.



■ Thanks to the use of various materials, M Compound brakes achieve outstanding deceleration values and are extremely stable and highly durable. They also weigh less, which has a positive impact on agility, dynamics and acceleration. The Blue metallic brake callipers with the M designation are the hallmark of these high-performance M specific brakes.



■ The black X5 M Competition designation on the rear¹ is an indication of the vehicle's extraordinarily high driving dynamic potential.



■ You and your front passenger are welcomed by front door sill finishers with the "X5 M Competition" designation¹ as soon as you get in. The designation on the inserts in Black in the door sill finishers in the front on the left and right radiates quality and exclusivity.



■ 21" M light alloy wheels Double-spoke style 808 M Bicolour Orbit Grey with mixed tyres, gloss-lathed, front 10.5J x 21 with 295/35 R21 tyres, rear 11.5J x 21 with 315/35 R21 tyres.



□ 21"/22" M light alloy wheels Star-spoke style 809 M Bicolour Black with mixed tyres, gloss-lathed, front 10.5J x 21 with 295/35 R21 tyres, rear 11.5J x 22 with 315/30 R22 tyres.²

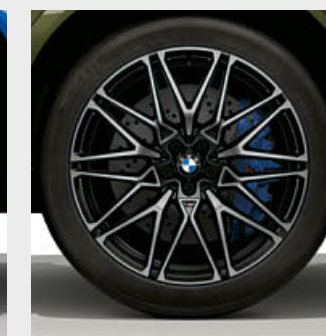

■ 21"/22" M light alloy wheels Star-spoke style 818 M Bicolour Black with mixed tyres, gloss-lathed, front 10.5J x 21 with 295/35 R21 tyres, rear 11.5J x 22 with 315/30 R22 tyres.¹

¹ Only available for Competition models.
² Standard for Competition models.

*The availability of some equipment features and functions depends on engine variants or additional options. The market and production availability may vary. You can find detailed information about terms, standard and optional equipment at www.bmw.com or at your BMW Partner.

HIGHLIGHTS.

Discover even more with the new BMW brochures app. Available now, for your smartphone and tablet.

■ Standard equipment □ Optional equipment



■ The M Multifunctional seats for the driver and front passenger in exclusive design and with illuminated X6 M logo on the headrest reflect the vehicle's athletic look. Lower seat bases and high side bolsters emphasize the shell-seat look and guarantee flawless lateral support. Accompanied by a comprehensive range of adjustment possibilities, maximum comfort is achieved.



□ The M Sport exhaust system¹ delivers a dynamic sound that can be modified via the integrated exhaust valve mechanism. The SPORT and SPORT+ programmes, which can be selected via the Driving dynamics buttons, are accentuated by an even more intense engine sound, while the comfort-oriented programme prioritises more discreet engine acoustics.



■ The BMW Live Cockpit Professional with navigation function includes two high-quality displays consisting of a high-resolution 12.3" Control Display that can be operated by touch and a fully digital 12.3" instrument display.



■ The full-colour BMW Head-Up Display³ * incl. M specific display projects all information relevant to the journey directly into your field of vision, allowing you to fully concentrate on driving. Information such as the current speed and, depending on the equipment, navigation directions, Speed Limit Info including no-overtaking indicator, along with telephone and entertainment lists are displayed.



□ The M Carbon rear spoiler² emphasises the vehicle's exclusivity and powerful, sporty design and noticeably reduces unwanted aerodynamic uplift on the rear axle.



□ The M Carbon mirror caps with M typical double-bridged design emphasise the powerful, sporty design of the vehicle.



□ The M Carbon engine cover creates a genuine racing atmosphere when the bonnet is up.



■ The 8-speed M Steptronic transmission with Drivelogic offers numerous shifting options: from extremely dynamic to highly comfortable, manual or automatic.



□ The Automatic air conditioning with 4-zone control allows individual climate comfort for you and your front passenger, as well as for the right and left rear passengers.



□ The Bowers & Wilkins Diamond surround sound system* features a 1,500-watt output and outstanding studio-quality sound for all seats in the vehicle.

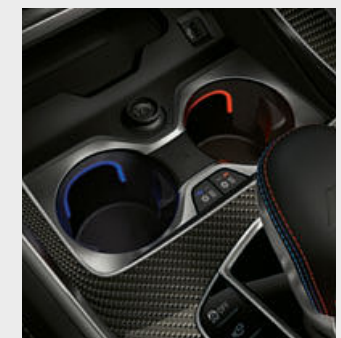

□ The temperature-controlled cupholders in the centre console can individually cool or keep stored beverages warm at the touch of a button.



□ The Panorama glass roof Sky Lounge creates a generous sense of space during the day, while at night it lends an atmospheric mood with a light design consisting of more than 15,000 light elements. The light design can be switched between the six colours of the Ambient light.



□ Rear-seat entertainment Professional includes two separate high-resolution 10.2" colour screens with touch function that can be tilted and a Blu-ray drive. In this way, it becomes possible to use navigation and internet functions while driving (if a mobile phone contract exists). Additionally, a USB port and connections for MP3 players, game consoles and headphones (even wireless) are included.



□ Parking Assistant Plus makes parking and manoeuvring the vehicle easier. It features among others the Surround View system including Top View, Panorama View, Remote View 3D, as well as a lateral parking aid, the emergency braking function Active Park Distance Control, Parking Assistant with longitudinal and lateral guidance and Reversing Assistant.

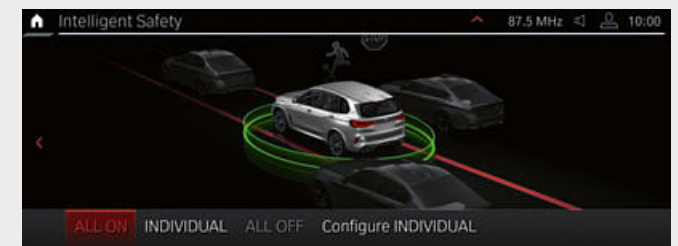

□ Driving Assistant Professional⁴ * offers optimum comfort and safety during critical or monotonous traffic situations. Apart from the contents of the Driving Assistant, it also includes Steering and Lane Control Assistant with extended functions, Lane Change and Emergency Stop Assistant and Lane Keeping Assistant with active side collision protection.

¹ Standard for Competition models.

² Only available for BMW X6 M and BMW X6 M Competition.

³ The information in the BMW Head-Up Display is not fully visible when viewed through

polarised sunglasses. Content shown will depend on the equipment options chosen. Further optional equipment is required to display specific items.

⁴ Function may be limited in darkness or in fog.

* The availability of some equipment features and functions depends on engine variants or additional options. The market and production availability may vary. You can find detailed information about terms, standard and optional equipment at www.bmw.com or at your BMW Partner.

Some ConnectedDrive Services may differ between countries. Please consult your local BMW partner for more information.

EXTERIOR COLOURS.

Discover even more with the new BMW brochures app. Available now, for your smartphone and tablet.

■ Standard equipment □ Optional equipment



■ Non-metallic 300 Alpine White



■ Metallic A96 Mineral White



■ Metallic C28 M Donington Grey

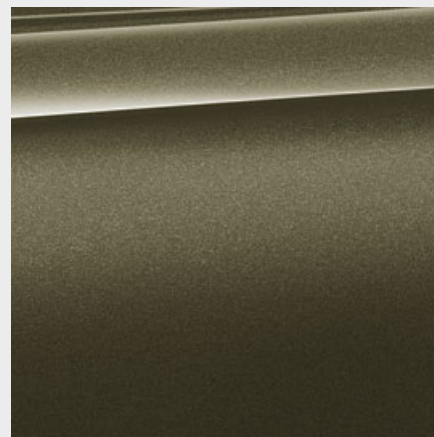

■ Metallic C3D Manhattan

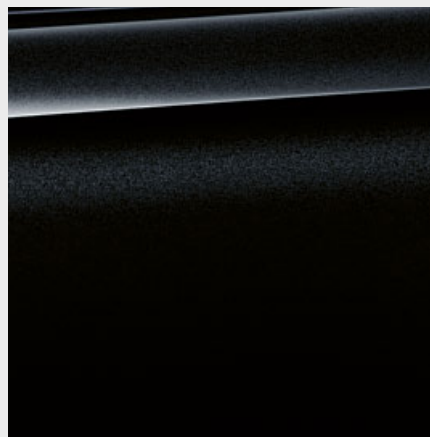

■ Metallic 475 Black Sapphire

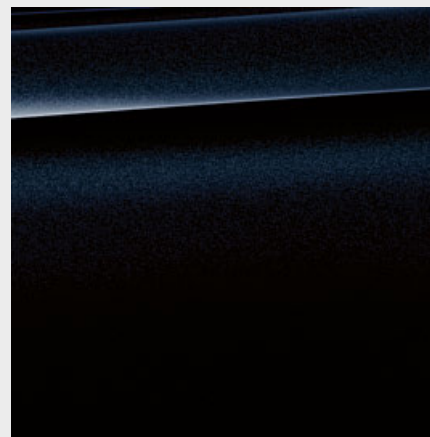

■ Metallic 416 M Carbon Black



■ Metallic C1K M Marina Bay Blue

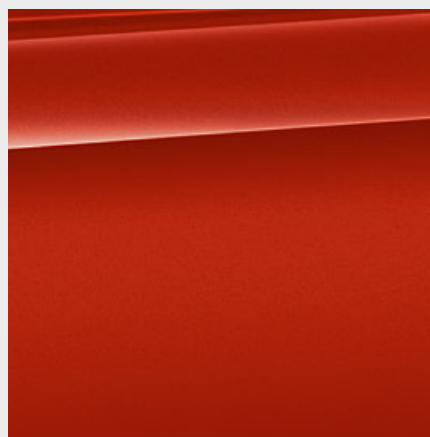

■ Metallic C3G M Toronto Red

BMW INDIVIDUAL

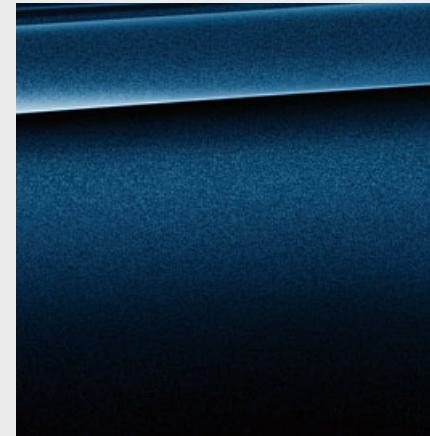

□ BMW Individual C3Z Tanzanite Blue metallic

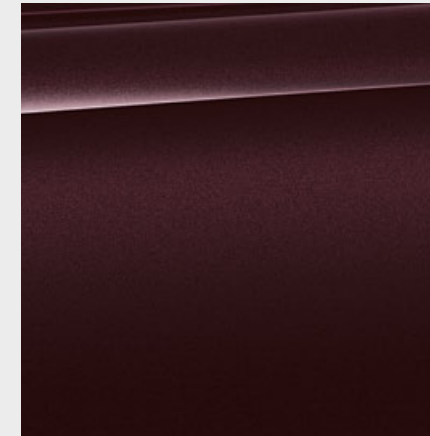

□ BMW Individual X1B Ametrine metallic



□ BMW Individual 490 special paintwork (e.g. Urban Green non-metallic)

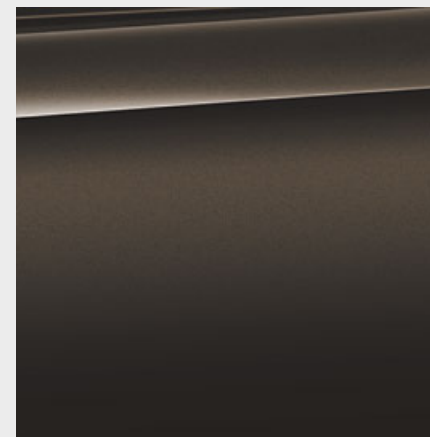

□ BMW Individual C36 Dravit Grey metallic

[Colour samples] These colour samples are intended as an initial guide to the colours and materials available for your BMW. However, experience has shown that printed versions of paint, upholstery and interior trim colours cannot in all cases faithfully reproduce the

appearance of the original colour. Please discuss your preferred colour choices with your BMW partner or in your dealership. There you can also see original samples and be assisted with special requests.

The availability of some equipment features and functions depends on engine variants or additional options. The market and production availability may vary. You can find detailed

information about terms, standard and optional equipment at www.bmw.com or at your BMW Partner.

INTERIOR COLOURS.

Discover even more with the new BMW Brochures app. Available now, for your smartphone and tablet.

LEATHER



■ Leather 'Merino' LKSW with extended contents Black



■ Full leather 'Merino'/Alcantara combination HEJA Black/contrast Midrand Beige¹

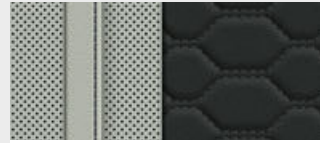

□ Full leather 'Merino' X3A9 Silverstone²



□ Full leather 'Merino' X3HV Adelaide Grey²

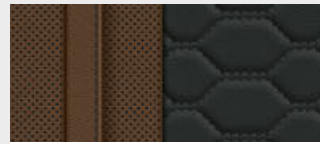

□ Full leather 'Merino' X3JT Taruma Brown²



□ Full leather 'Merino' X3SW Black²

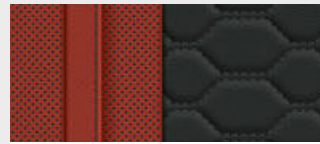

□ Full leather 'Merino' X3DA Sakhir Orange²

BMW INDIVIDUAL LEATHER

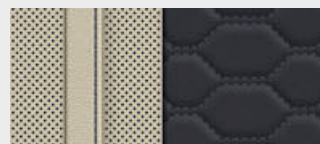

□ BMW Individual full leather trim 'Merino' ZBEI Ivory White/Midnight blue*

INTERIOR TRIM FINISHERS



■ M interior trim finishers Aluminium 'Crossline'

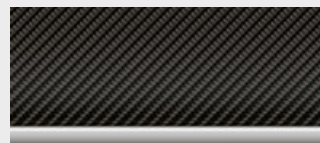

□ M interior trim finishers 'Carbon Fibre'

BMW INDIVIDUAL INTERIOR TRIM FINISHERS



□ BMW Individual interior trim finishers fine-wood trim Ash Grain Silver Grey high-gloss

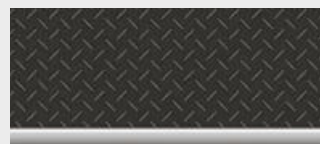

□ BMW Individual fine-wood trim 'Fineline' Black



□ BMW Individual interior trim finishers piano finish Black

¹ Only available for Competition models.

² Standard for Competition models.

*The availability of some equipment features and functions depends on engine variants

or additional options. The market and production availability may vary. You can find detailed information about terms, standard and optional equipment at www.bmw.com or at your BMW Partner.

BMW M PERFORMANCE PARTS.

Equipment 24 | 25

■ Standard equipment □ Optional equipment ○ Accessories

PERFORMANCE PARTS



○ Show your style: The frame of the M Performance kidney grille¹ is made of premium carbon fibre. For an especially elegant, sporty and individual look.



○ Show your style: The frame of the M Performance kidney grille² is made of premium carbon fibre. For an especially elegant, sporty and individual look.



○ With its striking shape and distinctive Alcantara grip area, the steering wheel¹ provides an unmistakable motorsport atmosphere in the cockpit.



○ Moving design. The M Performance roof spoiler¹ is made of PUR in Black high-gloss, an elegantly athletic accent for the rear of the vehicle.



○ Where dynamism meets elegance: The M Performance rear fins² are refined and powerful at the same time – emphasising the sporty look of the vehicle.



○ Even more impressive: The M rear spoiler² made of carbon fibre enhances the vehicle's sophisticated, sporty looks.



○ Make a powerful statement: carbon fibre cover and other design features make the titanium tail pipe trim seem extremely solid and powerful.



○ The M Performance door projector slides complement the BMW LED door projectors by adding four changeable M Performance images.



○ The M Performance tyre bags protect the driver and the vehicle from getting dirty when transporting the wheels. In sporty M Performance design.

¹ Only available for BMW X5 M.

² Only available for BMW X6 M.

Discover the wide range of innovative solutions available for the exterior and interior, communication and information, and for transportation and the luggage compartment.

Your BMW Partner is on hand to advise you on the whole range of Original BMW Accessories and the BMW M Performance Parts product portfolio. For further information, please visit www.bmw.com

		BMW X5 M	BMW X5 M Competition	BMW X6 M	BMW X6 M Competition
--	--	----------	----------------------	----------	----------------------

Weight					
Unladen weight EU ¹	kg	2410	2410	2395	2395
Maximum permissible weight	kg	3000	3000	3000	3000
Permitted load	kg	665	665	680	680
Permitted trailer load, unbraked ²	kg	750	750	750	750
Permitted trailer load, braked, max. 12% gradient/max. 8% gradient ²	kg	3000 ³ -2700/ 3000 ³ -2700	3000 ³ -2700/ 3000 ³ -2700	3000 ³ -2700/ 3000 ³ -2700	3000 ³ -2700/ 3000 ³ -2700
Luggage capacity	l	650-1870	650-1870	580-1530	580-1530

BMW M TwinPower Turbo engine ⁴					
Cylinders/valves		8/4	8/4	8/4	8/4
Capacity	cm ³	4395	4395	4395	4395
Max. output/engine speed	kW (hp)/ rpm	441 (600)/ 6000	460 (625)/ 6000	441 (600)/ 6000	460 (625)/ 6000
Max. torque/engine speed	Nm/ rpm	750/ 1800-5600	750/ 1800-5860	750/ 1800-5600	750/ 1800-5860

Power transmission					
Type of drive		M xDrive	M xDrive	M xDrive	M xDrive
Standard transmission		M Steptronic transmission	M Steptronic transmission	M Steptronic transmission	M Steptronic transmission

Performance					
Top speed	km/h	250 ⁵	250 ⁵	250 ⁵	250 ⁵
Top speed with optional M Driver's Package ⁶	km/h	290	290	290	290
Acceleration 0-100 km/h	s	3.9	3.8	3.9	3.8

Fuel consumption ^{4,7}					
Urban	l/100km	18.3	18.3	18.6	18.6
Extra-urban	l/100km	10.4	10.4	9.9	9.9
Combined	l/100km	13.3	13.3	13.1	13.1
Exhaust emissions standard (type-certified)		EU6d	EU6d	EU6d	EU6d
Combined CO ₂ emissions	g/km	303	303	301	301
Tank capacity, approx.	l	83	83	83	83

Wheels/tyres					
Tyre dimensions		295/35 ZR21 Y 315/35 ZR21 Y	295/35 ZR21 Y 315/30 ZR22 Y	295/35 ZR21 Y 315/35 ZR21 Y	295/35 ZR21 Y 315/30 ZR22 Y
Wheel size		10.5 x 21 11.5 x 21	10.5 x 21 11.5 x 22	10.5 x 21 11.5 x 21	10.5 x 21 11.5 x 22
Material		Light alloy	Light alloy	Light alloy	Light alloy

BMW X5 M

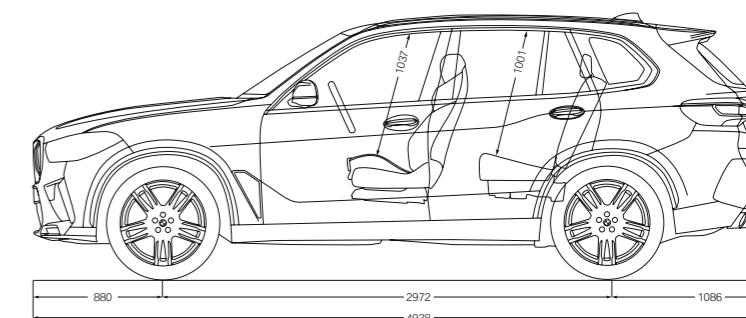
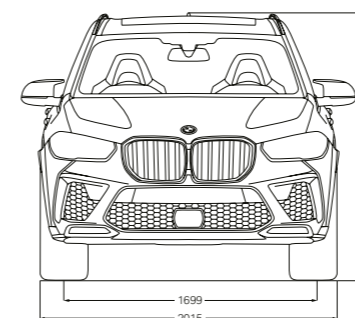

BMW X6 M

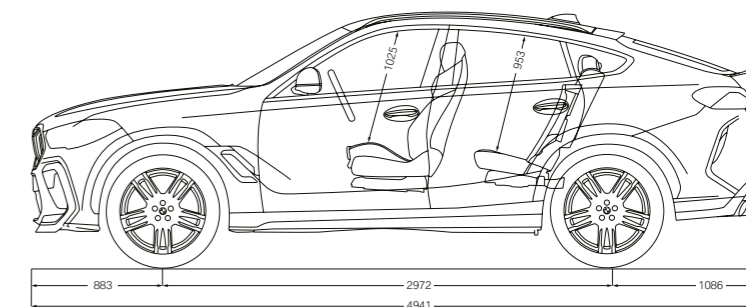
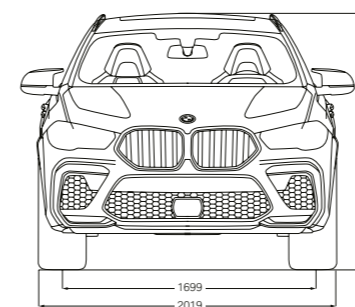

¹ The EC unladen weight refers to a vehicle with standard equipment and does not include any optional extras. The unladen weight includes a 90% full tank and a driver weight of 75 kg. Optional equipment may affect the weight of the vehicle, the payload and the top speed if the selected equipment has an impact on the vehicle's aerodynamics.

² The actual total weight of the trailer must not exceed the maximum trailer load, taking into account the maximum tow bar download.

³ Only with factory-fitted trailer tow hitch.

⁴ Performance data of petrol engines apply to vehicles using RON 98 fuel. Fuel consumption data apply to vehicles using reference fuels in accordance with EU Regulation 2007/715. Unleaded RON 91 and higher with a maximum ethanol content of 10% (E10) may also be used. BMW recommends RON 98 super plus unleaded petrol.

⁵ Electronically limited.

⁶ The raised top speed is only available after the first service following the 2,000 km run-in period.

⁷ The official data for fuel consumption and CO₂ emissions were determined in accordance with the measurement processes as defined by European Regulation (EC) 715/2007 in the applicable version. The ranges take into account differences in the selected wheel and tyre size. Figures have been determined on the basis of the new WLTP test cycle and have been converted back into NEDC figures for comparability. Values other than those specified here may apply for the assessment of taxes and other vehicle-related charges that are (also) based on CO₂ emissions.

*Height applies to M Competition model.



YOUR NEW SPEED DATING APP.

DOWNLOAD NOW THE BMW BROCHURES APP FROM YOUR APP STORE AND DISCOVER DRIVING PLEASURE!

BMW X5 M COMPETITION:

BMW M TwinPower Turbo 8-cylinder petrol engine, 460 kW (625hp), 21"/22" light alloy wheels Star-spoke style 809 M Bicolour with mixed tyres, exterior colour in M Marina Bay Blue metallic, M multifunction seats for driver and front passenger in full leather 'Merino' in Silverstone, M interior trim finishers Aluminium 'Crossline'.

BMW X6 M COMPETITION:

BMW M TwinPower Turbo 8-cylinder petrol engine, 460 kW (625hp), 21"/22" light alloy wheels Star-spoke style 818 M Bicolour with mixed tyres, exterior colour in Urban Green uni, M multifunction seats for driver and front passenger in full leather 'Merino'/Alcantara combination Black/contrast Midrand Beige, M interior trim finishers 'Carbon Fibre'.

The models illustrated in this medium show the equipment and configuration options (standard and optional) for vehicles produced by BMW AG for the German market. Alterations in standard and optional equipment and the configurations available for the different models, as described in this medium, may occur after 11/11/2020, the editorial deadline for this medium, or according to the specific requirements of other member states of the European Union. Your local BMW Partner is available to provide further details. Subject to change in design and equipment.

Of course, each vehicle is designed for economical recycling after its long-running life. You can find more information regarding your end-of-life vehicle on our website www.bmw.de/recycling

© BMW AG, Munich, Germany. Not to be reproduced wholly or in part without prior written permission of BMW AG, Munich.

XXXXXXXXXX 20XX CB. Printed in Germany 2021.